

部番	部品名	個数
1	ベアリングハウジング	1
2	ベアリング	1セット
3	押エブタ又は押エナット	1
4	六角穴付きボルト	4
5	スペーサ	1
6	ロックナット	1
7	マワリ止め小ネジ	1

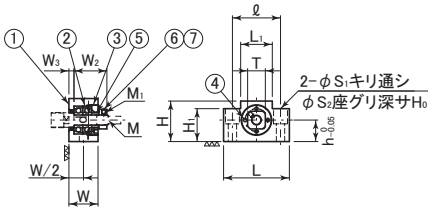

SUH6, 8

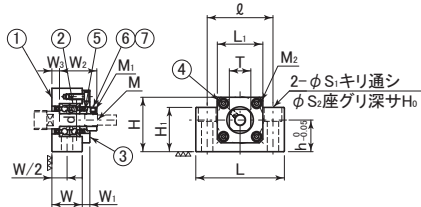

SUH10, 12, 15

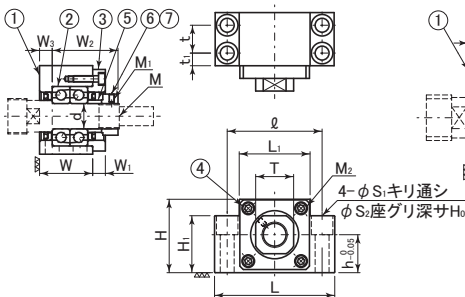

SUH20

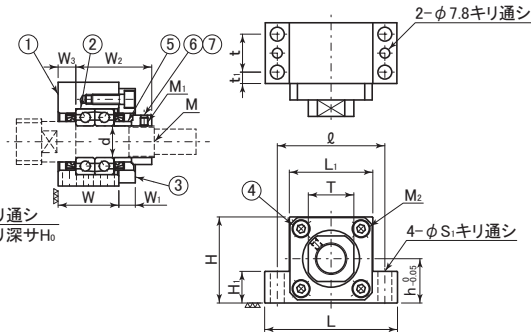

SUH25

表287 : SUHシリーズ寸法表

単位 : mm

型番	ハウジング主要寸法																			ベアリング	
	d	h <sub>-0.05</sub>	H	H <sub>1</sub>	L	ℓ	L <sub>1</sub>	W	W <sub>1</sub>	W <sub>2</sub>	W <sub>3</sub>	t	t <sub>1</sub>	S <sub>1</sub>	S <sub>2</sub>	H <sub>0</sub>	M	M <sub>1</sub>	M <sub>2</sub>		T
SUH6	6	13	25	20	42	30	18	20	-	22	3.5	-	-	5.5	9.5	11	M6	M3	-	12	706ATYDFC7P5
SUH8	8	17	32	26	52	38	25	23	-	26	4	-	-	6.6	11	12	M8	M3	-	14	708ATYDFC8P5
SUH10	10	25	43	35	70	52	36	24	6	29.5	6	-	-	9	14	11	M10	M4	M4	17	7000ATYDFC8P5
SUH12	12	25	43	35	70	52	36	24	6	29.5	6	-	-	9	14	11	M12	M4	M4	19	7001ATYDFC8P5
SUH15	15	30	50	40	80	60	41	25	6	38	5	-	-	11	17	15	M15	M4	M4	22	7002ATYDFC8P5
SUH20	20	30	58	45	95	75	56	42	10	52	10	22	10	11	17	15	M20	M4	M6	30	7204ATYDFC8P5
SUH25	25	35	68	25	105	85	66	48	13	60	14	30	9	11	-	-	M25	M6	M8	36	7205ATYDFC8P5



部番	部品名	個数
1	ベアリングハウジング	1
2	ベアリング	1セット
3	押エボタ又は押エナット	1
4	六角穴付ボルト 又はサラ小ネジ	4
5	スペーサ	1
6	ロックナット	1
7	マワリ止め小ネジ	1

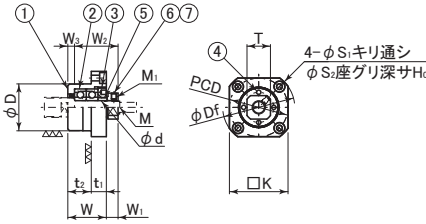

SUF6, 8

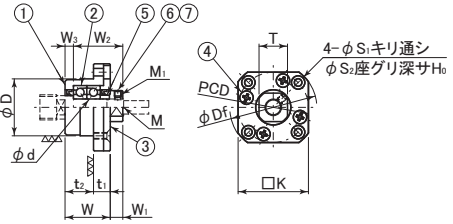

SUF10, 12

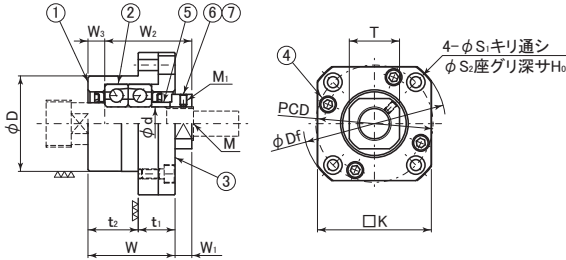

SUF15, 20, 25

表288 : SUFシリーズ寸法表

単位 : mm

型番	ハウジング主要寸法																	ベアリング
	d	$D_{g6}$	Df	PCD	W	$t_1$	$t_2$	$W_1$	$W_2$	$W_3$	K	$S_1$	$S_2$	$H_0$	M	$M_1$	T	
SUF6	6	22	35	28	20	7	13	5.5	22	3.5	28	2.9	5.5	3.5	M6	M3	12	706ATYDFC7P5
SUF8	8	28	43	35	23	9	14	7	26	4	35	3.4	6.5	4	M8	M3	14	708ATYDFC8P5
SUF10	10	34	52	42	27	10	17	7.5	29.5	5	42	4.5	8	4	M10	M4	17	7000ATYDFC8P5
SUF12	12	36	54	44	27	10	17	7.5	29.5	5	44	4.5	8	4	M12	M4	19	7001ATYDFC8P5
SUF15	15	40	63	50	32	15	17	12	38	6	52	5.5	9.5	6	M15	M4	22	7002ATYDFC8P5
SUF20	20	57	85	70	52	22	30	10	52	10	68	6.6	11	10	M20	M4	30	7204ATYDFC8P5
SUF25	25	63	98	80	57	27	30	13	60	10	79	9	15	13	M25	M6	36	7205ATYDFC8P5